

COLOSSUSTM

Excellence inside

DATASHEET

SS36IHI40900W

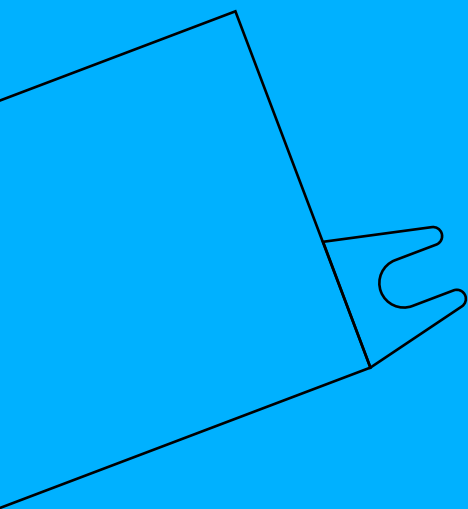

Version: 01

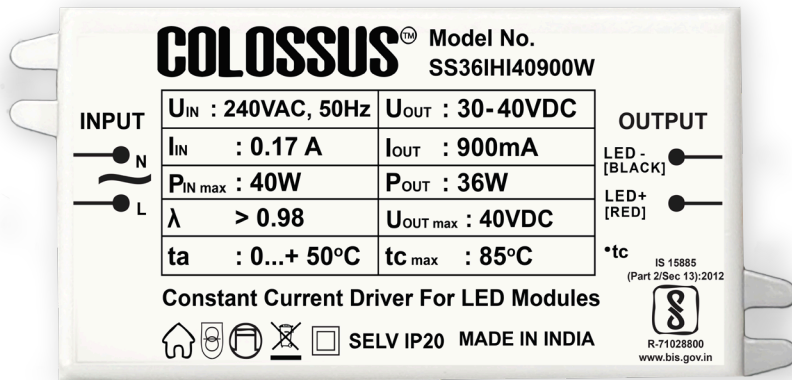

<https://colossusworld.com/>

*Image is for viewing purpose. Technical Data not to be drawn from above image.

Approval Markings:



Product Description

- Constant current driver for led modules
- Input Voltage 240VAC
- High efficiency >90%(@100% Load)
- Power factor >0.98, THD<10%(@100%Load)
- For use in combination with luminaries of protection class II.
- Protection against Abnormal Operating Conditions Like Input Over Voltage Protection, Under Voltage Protection, Short Circuit Protection, Open Voltage Protection, Overload Protection.
- Surge protection 4KV
- Nominal Life Time: 30,000 hours @ $t_c \leq t_{c\ max}$

Functions

- Application oriented operation for maximum compatibility

Applications

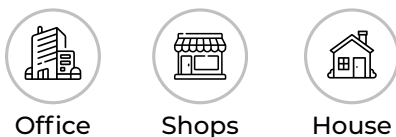

Technical Data

Mains Voltage Supply

Rated Voltage Range	240VAC
Rated Frequency	50/60 Hz
Max. Admissible Input Voltage Range(AC)	175-265VAC
Total Harmonic Distortion (THD)	<10% (@Full Load)
Mains Voltage Withstanding Capacity	440VAC for 2hrs (with overvoltage shutdown)

Output Data

Constant current

Output Current Tolerance	±5%
Max Starting Time	<1s

Interface And Dimming Operation

Dimming Interface	None
-------------------	------

Power Factor

240V(@ Full Load)	>0.98
-------------------	-------

Efficiency(typ.)

Full Load	>90%
-----------	------

Protections

Open Circuit	<50VDC
Output Short Circuit Operation	YES
Input Over Voltage Cutoff	290VAC ±10%
Input Under Voltage Cutoff	100VAC ±10%

Connection Wires

Type	Solid or Stranded Wire
Wire Cross Section	0.5mm ² - 1.5mm ²
Wire Length	150mm (±15mm)

Wire Lengths

Max. Wire Length To Led Module	<1m
--------------------------------	-----

Housing Properties

Degree of protection	IP20
Casing	Polycarbonate, White

Housing Dimensions

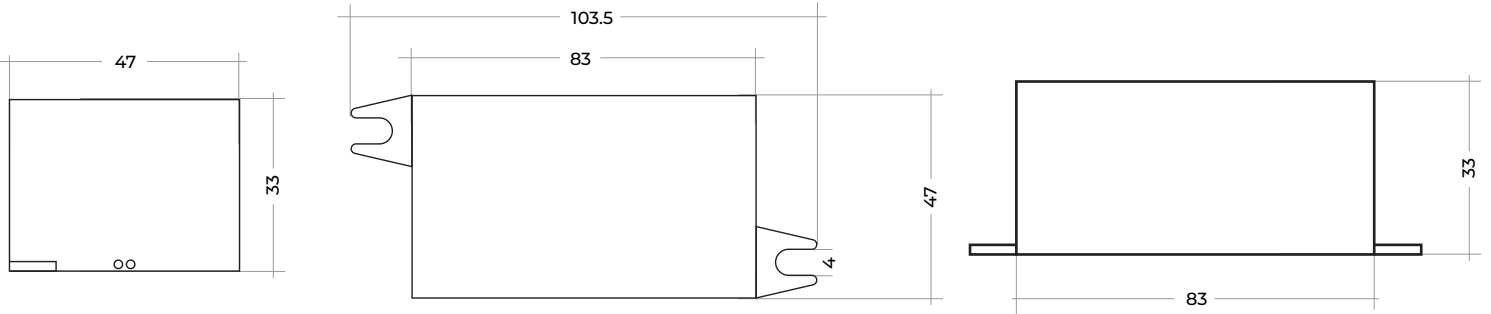

Dimensions	103x47x33mm
Tolerance	± 1mm
Weight	170 gm

Wiring Diagrams

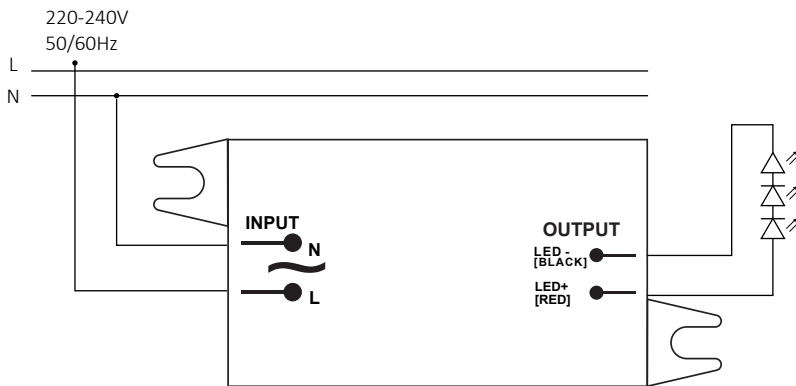

Expected Lifetime

Lifetime	30,000 hours
Warranty	2 years

Logistics Data

Model No.	SS36IHI40900W
Weight (gm)	170 gm

Protection

Surge	4kV
High Voltage	440V

Temperatures (Operation)

Model No.	Ambient(ta)	Case (tc)
SS36IHI40900W	0°C... +50°C	Max + 85°C

Product Specifications

Model No.	Input Current (max)	Input Power (max)	THD	Power Factor	Efficiency	Output Current	Output Voltage	Output Power (max)
SS36IHI40900W	170mA	40W	<10%	>0.98	>90%	900mA	30-40V	36W

All specifications with 240 VAC are nominal operation and 100% load.

Graphs

Operating Window

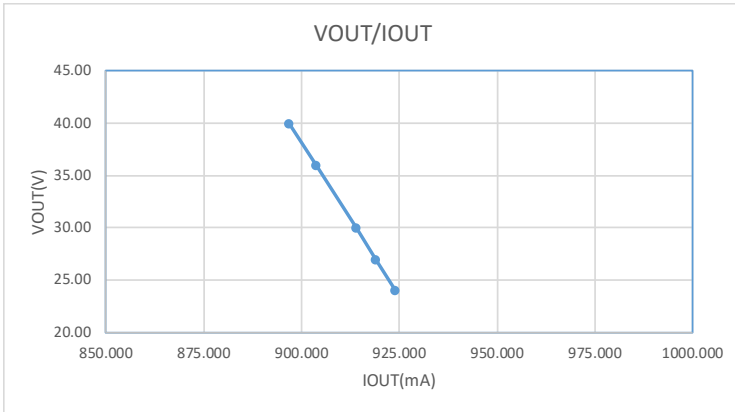

Efficiency Vs Output Power

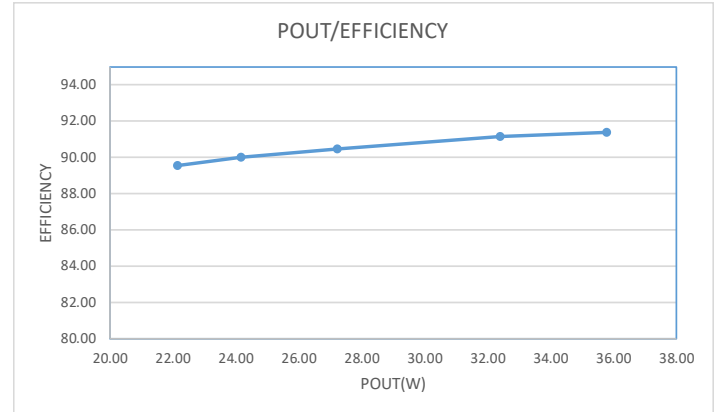

THD Vs Output Power

